

PTU05

825B071F

Compact ultrasonic level transmitter

TECHNICAL DATA

Enclosure material:	PP
Mechanical installation:	1" BSP
	on request with PP DN100 PN6 flange screwed
Mechanical protection:	IP68
Electrical connection:	n.1 output cables (L=3m) or IP68 male connector with linking cable
Working temperature:	-25 ÷ +75°C
Pressure:	from 0,5 to 1,5bar (absolute)
Power supply:	24Vdc
Power consumption:	1W
Analog output:	4-20mA max load 750 ohm
Serial port:	RS485
Max measure range:	0,3+5m
[The above distance must be intended from perfect reflecting surfaces, in contrary case decreases the maximum measurable distance]	
Temperature compensation:	PT100 from -30 to +80°C
Accuracy:	+/- 0,5% not better than +/-2mm
Resolution:	1mm
Calibration:	two push-buttons, for self-acquisition or by SWING unit
Warm-up:	30 minutes normally
LEDs display:	red LED for supply yellow LED flashing for echo receiving



PTU05 Mechanical installation

To reach a good and safe measurement, avoiding spurious echo (not reflected from the surface to measure) need to take care about the sensor sensibility volume in the sound path, no obstacles or objects must be present into the sensibility volume (lobe), see fig.2/D/E.

On fig.2 some suggestion:

- 1) Install perpendicular at the surface, see fig.2/A
- 2) Don't use with foaming products, see fig.2/B
- 3) Avoid installation where the product distance could be less than 0,3m, see fig.2/C
- 4) No obstacles or objects must be present into the sensibility volume, see fig.2/D/E

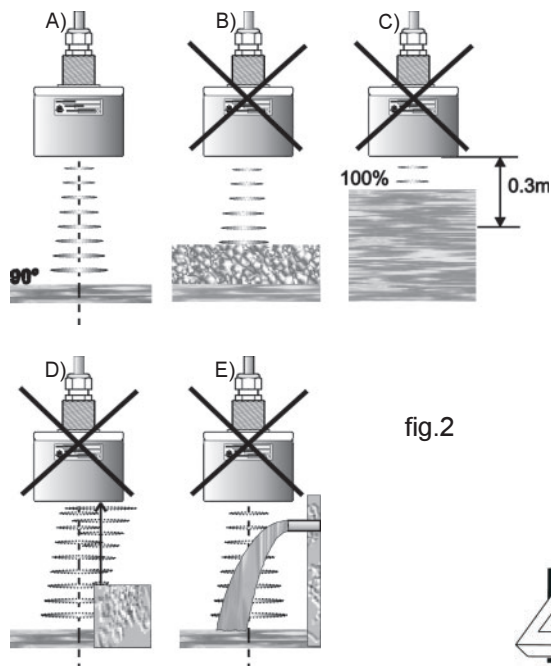

fig.2



LEKTRA

PTU05 Overall dimensions

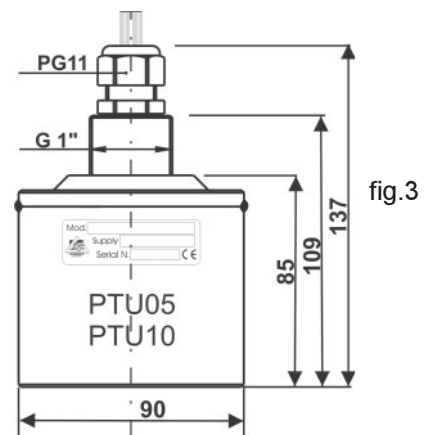

fig.3

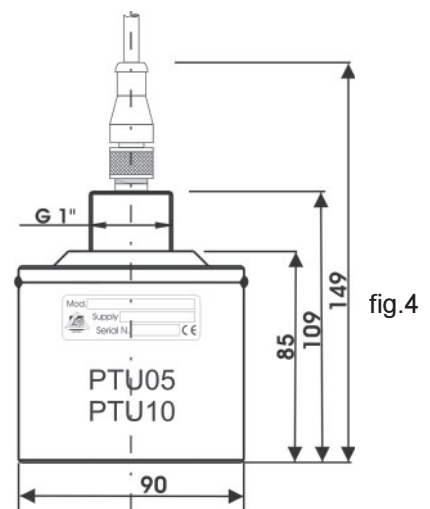

fig.4

PTU05 Electrical Connections

No special cable or coax-cable are requests, and no practice distance limits.

For the Vdc power supply take in consideration that the negative of the power supply is electrically connected to the negative output current.

A special J-box with P1 and P2 calibration push buttons built-in is available on request.

The picture below shows the connectors and the push-buttons for the 4÷20mA version calibration.

Available a RS485 serial port to communicate to PC or PLC.

On request the "SoniSoft" S/W communication for PC and the RS485/RS232 conversion module are available.

Analog output version

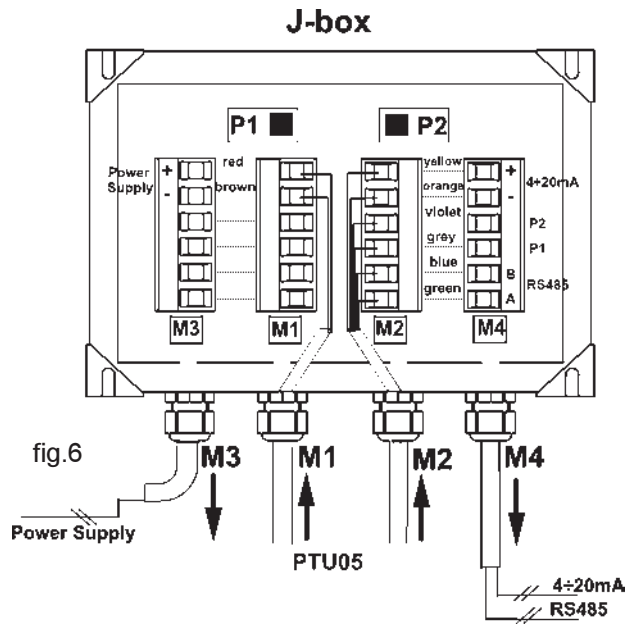

SWING connections

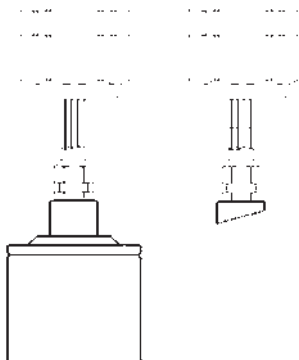
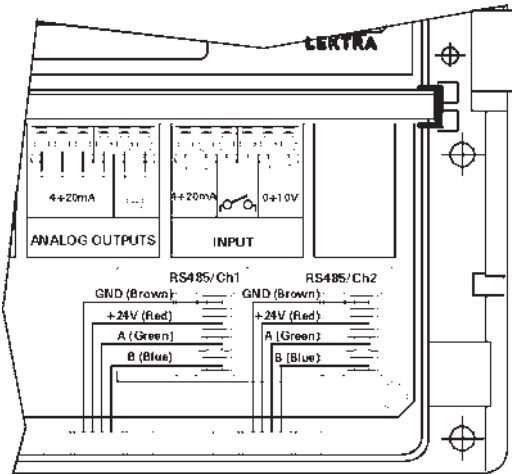

fig.5

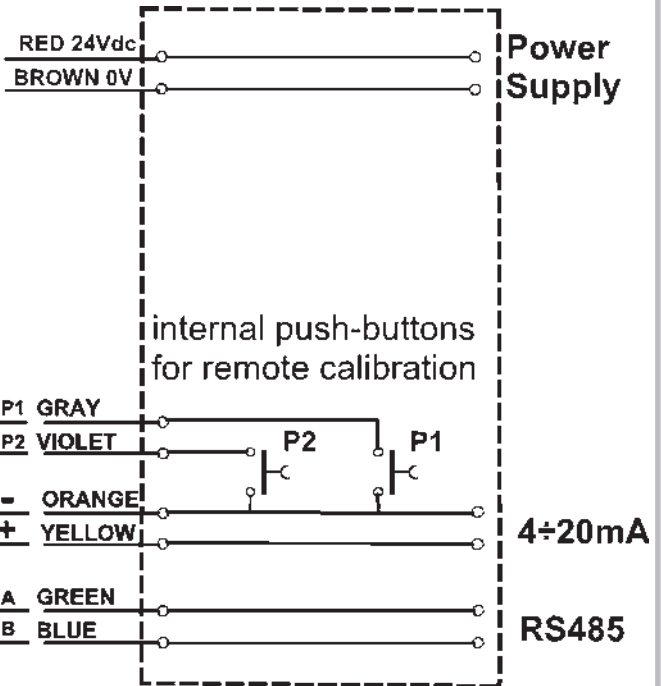

fig.7

PTU05 Calibration

The PTU05 calibration can be done in two different ways:

- a) By means the P1 and P2 push-buttons.
- b) With PC or PLC soft. communication with RS485 port.

a) By means the P1 and P2 push-buttons

To calibrate by-means 2 push-buttons P1 and P2 (see figure), needs to put the "PTU05" respectively at the distance refers to 0% and 100% level, in order to memorise the relevant distance electronically. In the condition of normal working the PTU05 shows led flashing (when echo is received).

To calibrate 4mA needs to put the PTU05 at the distance at which you want 4mA output current. Wait till the led is flashing than: press simultaneously P1 and P2, release them and verify that led will stay fix lightened. Press two times P1, release it and wait until led is flashing again before move the sensor. The distance has been memorised and associated to 4mA output.

To calibrate 20mA needs to put the PTU05 at the distance at which you want 20mA output. Wait till the led is flashing than: press simultaneously P1 and P2, release them and verify that led will be fix lightened. Press two times P2, release it and wait until led is flashing again before move the sensor. The distance has been memorised and associated to 20mA output.

b) With PC or PLC soft. communication with RS485 port
Refers to the "SoniSoft" S/W operating manual

Calibrations via SWING RS485 connection
Refers to the "SWING" operating manual

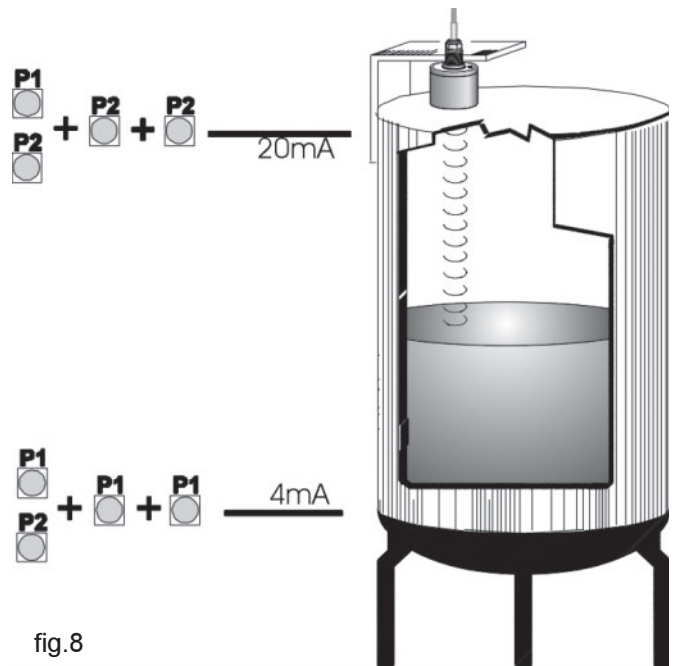

fig.8

run mode	calibration mode	enter setpoints	run mode
flashing	fix lighted	fix lighted	flashing
	P2	x y	
	P1	P1 + P1 = 4mA	
		P2 + P2 = 20mA	

fig.9



fig.11

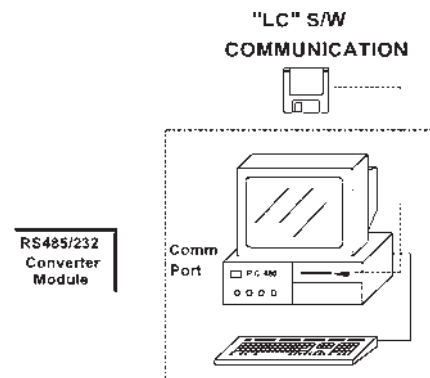

fig.10

